

WIPO IP Facts and Figures 2020

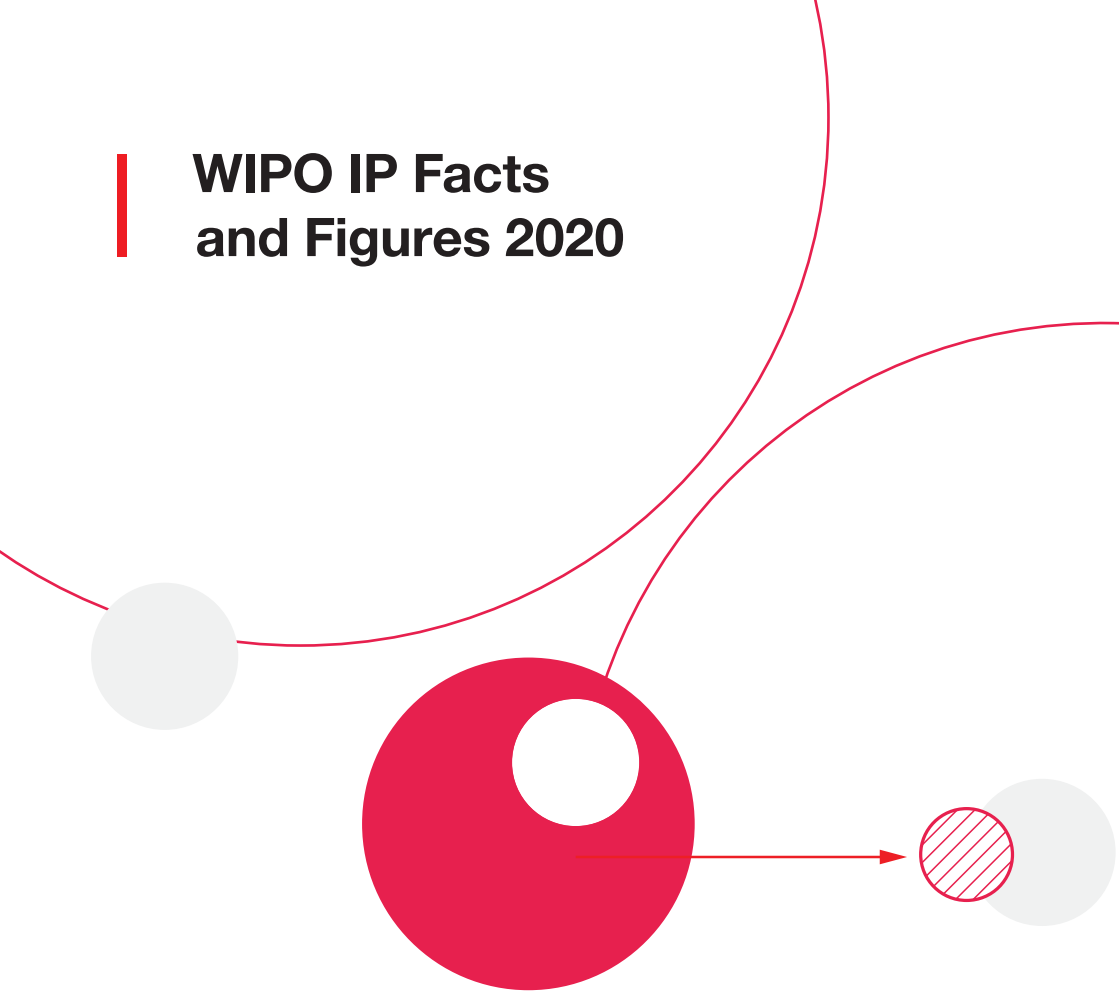



WIPO IP Facts and Figures 2020



Except where otherwise indicated, this work is licensed under the Creative Commons Attribution 3.0 IGO License.

The user is allowed to reproduce, distribute, adapt, translate and publicly perform this publication, including for commercial purposes, without explicit permission, provided that the content is accompanied by an acknowledgement that WIPO is the source and that it is clearly indicated if changes were made to the original content.

Adaptation/translation/derivatives should not carry any official emblem or logo, unless they have been approved and validated by WIPO. Please contact us via the WIPO website to obtain permission.

For any derivative work, please include the following disclaimer: "The Secretariat of WIPO assumes no liability or responsibility with regard to the transformation or translation of the original content."

When content published by WIPO, such as images, graphics, trademarks or logos, is attributed to a third-party, the user of such content is solely responsible for clearing the rights with the right holder(s).

To view a copy of this license, please visit:
<https://creativecommons.org/licenses/by/3.0/igo>

The designations employed and the presentation of material throughout this publication do not imply the expression of any opinion whatsoever on the part of WIPO concerning the legal status of any country, territory or area or of its authorities, or concerning the delimitation of its frontiers or boundaries.

This publication is not intended to reflect the views of the Member States or the WIPO Secretariat.

The mention of specific companies or products of manufacturers does not imply that they are endorsed or recommended by WIPO in preference to others of a similar nature that are not mentioned.

© WIPO, 2020

World Intellectual Property
Organization
34, chemin des Colombettes
P.O. Box 18
CH-1211 Geneva 20
Switzerland

ISBN: 978-92-805-3208-1



Attribution 3.0 IGO license
(CC BY 3.0 IGO)

Printed in Switzerland

Table of contents

Introduction	5
--------------	---

Global intellectual property applications and active IP rights

1. Total applications worldwide, 2019	7
2. Percentage shares of IP filing activity by region, 2019	8
3. IP rights in force, 2019	9

Patents and utility models

4. Percentage shares of total patent applications by the top five offices, 2019	11
5. Patent applications for the top 10 offices, 2019	12
6. Patent applications for offices of selected low- and middle-income countries, 2019	13
7. Resident patent applications relative to GDP for the top 10 origins, 2019	14
8. The top three technology fields for each of the top five origins, 2016–2018	15
9. PCT international applications for the top 10 origins, 2019	16
10. Top 10 PCT applicants, 2019	17
11. Utility model applications for the top 10 offices, 2019	18
12. Utility model applications for offices of selected middle-income countries, 2019	19

Trademarks

13. Percentage shares of total trademark filing activity by the top five offices, 2019	21
14. Application class counts for the top 10 offices, 2019	22
15. Application class counts for offices of selected middle-income countries, 2019	23

16.	Resident trademark application class count relative to GDP for selected origins, 2019	24
17.	The top three industry sectors for each of the top five origins, 2019	25
18.	Madrid international applications for the top 10 origins, 2019	26
19.	Top 10 Madrid applicants, 2019	27

Industrial designs

20.	Percentage shares of total design filing activity by the top five offices, 2019	29
21.	Application design counts for the top 10 offices, 2019	30
22.	Application design counts for offices of selected middle-income countries, 2019	31
23.	Resident application design count relative to GDP for selected origins, 2019	32
24.	The top three industry sectors for each of the selected origins, 2019	33
25.	Designs in Hague international applications for the top 10 origins, 2019	34
26.	Top 10 Hague applicants, 2019	36

Additional information

Statistical tables	39
Statistical resources	47
Glossary	48

Introduction

IP Facts and Figures 2020 from the World Intellectual Property Organization (WIPO) provides an overview of intellectual property (IP) activity using the latest available year of complete statistics. The figures presented here are drawn from WIPO's more comprehensive *World Intellectual Property Indicators 2020*.

IP Facts and Figures serves as a quick reference guide covering four types of industrial property: patents, utility models, trademarks and industrial designs. It focuses primarily on application data, which is the most often used measure of IP activity. Trademark application data refer to class counts – that is, the number of classes specified in applications. This affords a better comparison of international trademark filing activity across IP offices, because applications in some jurisdictions may specify multiple classes of goods and services, while others require a separate application for each class. Similarly, industrial design data refer to design counts – that is, the number of designs contained in applications.

Unless otherwise stated, all data refer to activity in calendar year 2019 and growth means annual growth, that is, the change from 2018 to 2019.

Please note that, due to the continual updating of statistics, data provided in this publication may differ from previously published figures and from data available on WIPO's web pages. For greater in-depth analysis of WIPO and/or national office IP statistics, please visit the following Internet pages:

IP statistics: www.wipo.int/ipstats

World Intellectual Property Indicators: www.wipo.int/ipstats/en/wipi

Contact information:

Department for Economics and Data Analytics

e-mail: ipstats.mail@wipo.int

Global intellectual property applications and active IP rights

Patent filings worldwide declined by 3% in 2019 – the first decline since the 2009 financial crisis – whereas trademark and industrial design filing activity grew by 5.9% and 1.3%, respectively

1. Total applications worldwide, 2019

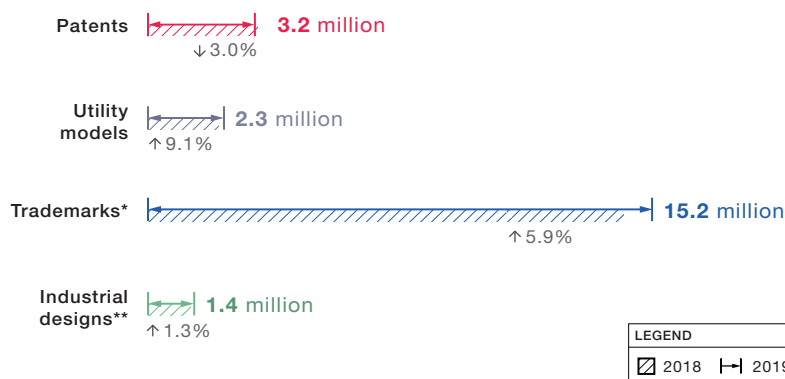

* refers to class count – the total number of goods and services classes specified in trademark applications.

** refers to design count – the total number of designs contained in industrial design applications.

Source: WIPO Statistics Database, September 2020.

In 2019, patent filings worldwide fell for the first time since the 2009 financial crisis, declining by 3%. In contrast, trademark and industrial design filing activity grew by 5.9% and 1.3%, respectively. In terms of volume, patent filings around the world numbered 3.2 million, trademark filing activity reached 15.2 million and industrial design filing activity totaled 1.4 million. Applications for utility models – a special form of patent right – grew by 9.1% to reach 2.3 million applications.

Offices in Asia account for the bulk of IP filing activity

2. Percentage shares of IP filing activity by region, 2019

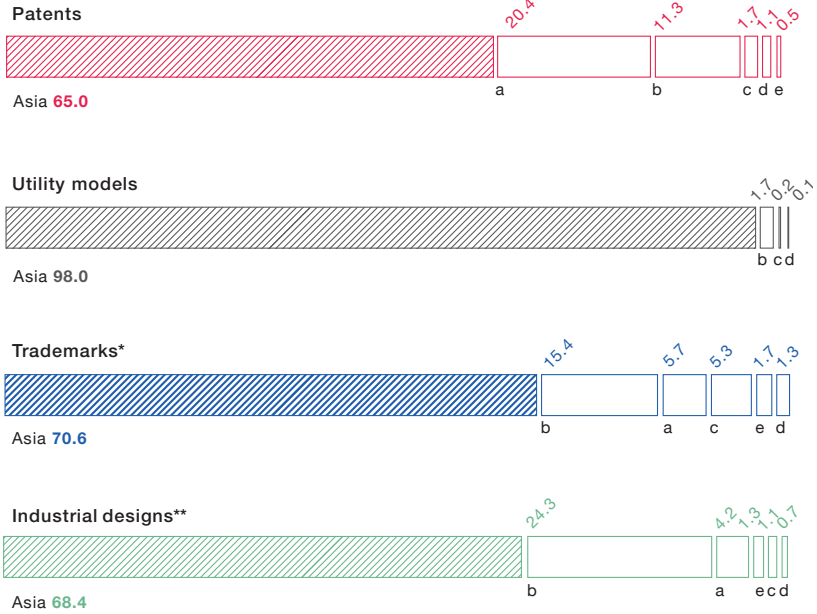

LEGEND	
▨	Asia
a	North America
b	Europe
c	Latin America and the Caribbean
d	Oceania
e	Africa

* refers to class count – the total number of goods and services classes specified in trademark applications.
 ** refers to design count – the total number of designs contained in industrial design applications.

Source: WIPO Statistics Database, September 2020.

Offices located in Asia account for around two-thirds of worldwide filing activity for patents, trademarks and industrial designs, and almost the entire global utility model filing activity. Over the past decade, Asia has increased considerably its share of applications filed around the world for all four of these IP rights.

Note that North American offices do not offer utility model registration and are therefore not included in the bar for that IP right in the chart opposite.

Around 15 million patents were in force globally in 2019

3. IP rights in force, 2019

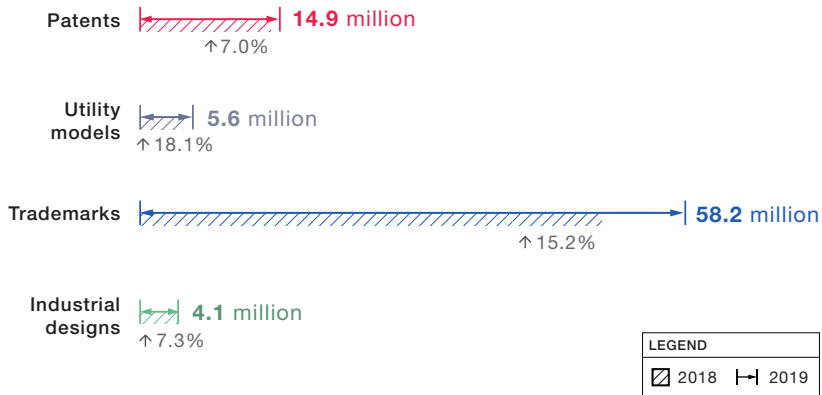

Source: WIPO Statistics Database, September 2020.

An estimated 14.9 million patents were in force worldwide in 2019. The highest numbers were in the United States of America (U.S.) (3.1 million), China (2.7 million) and Japan (2.1 million).

Of the 58.2 million trademark registrations active worldwide, the greatest number in force were in China (25.2 million), followed by the U.S. (2.8 million), India (2 million) and Japan (1.9 million). Likewise, China had the most industrial design registrations in force, accounting for 44% of the world total. In addition, China accounted for 94.2% of all utility models in force.

Patents and utility models

The top five offices accounted for 84.7% of the world total

4. Percentage shares of total patent applications by the top five offices, 2019

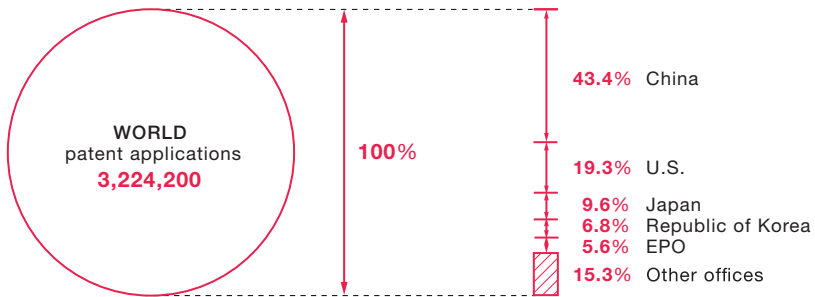

EPO is the European Patent Office.

Source: WIPO Statistics Database, September 2020.

Together, the top five offices accounted for 84.7% of the 3.2 million patent applications filed worldwide in 2019. This is 8.3 percentage points higher than their combined share in 2009 a decade earlier. China's office alone received 43.4% of the global total.

Despite a substantial decrease in filings on the previous year, the office of China still received the highest number of patent applications in 2019

5. Patent applications for the top 10 offices, 2019

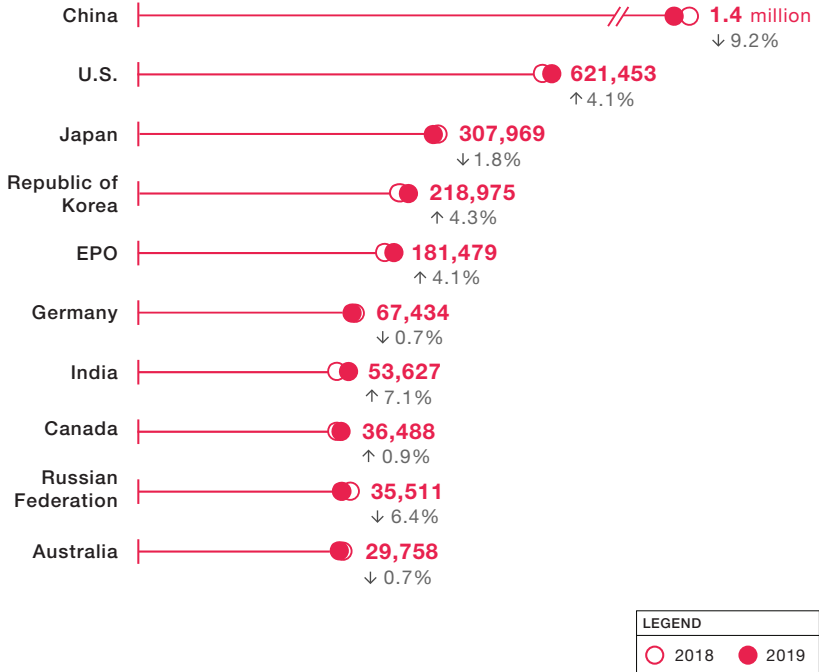

EPO is the European Patent Office.

Source: WIPO Statistics Database, September 2020.

In 2019, China’s IP office received 1.4 million patent applications, which is more than twice the amount received by the office of the U.S. China was followed by the offices of the U.S. (621,453), Japan (307,969), the Republic of Korea (218,975) and the European Patent Office (EPO) (181,479). Among top 10 offices, those of India (+7.1%), the Republic of Korea (+4.3%), the U.S. (+4.1%) and the EPO (+4.1%) saw a strong growth in filings received in 2019.

Among offices of selected low- and middle-income countries, Morocco and Turkey saw a rapid growth in patent applications in 2019

6. Patent applications for offices of selected low- and middle-income countries, 2019

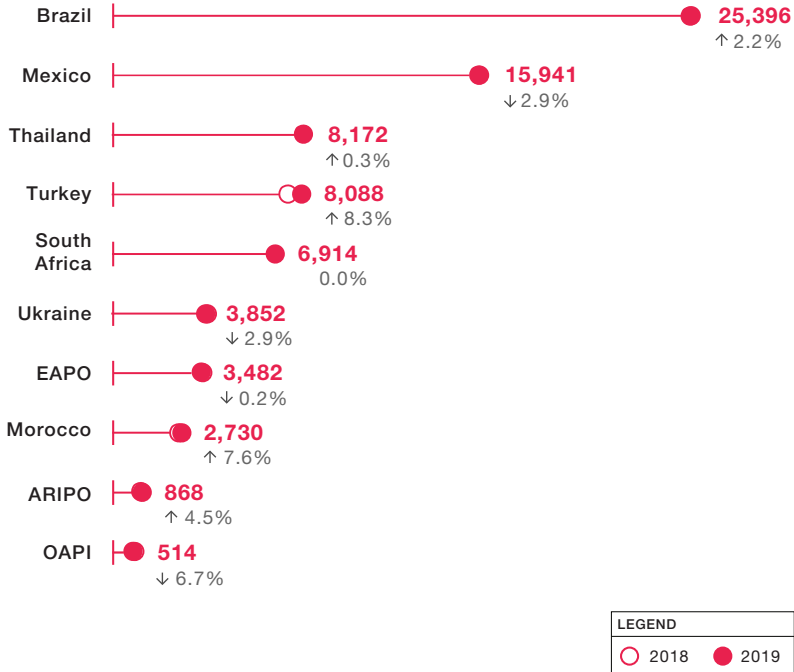

ARIPO is the African Regional Intellectual Property Organization; EAPO is the Eurasian Patent Organization; OAPI is the African Intellectual Property Organization. These regional offices act on behalf of their low- or middle-income member states.

Source: WIPO Statistics Database, September 2020.

Among offices of selected low- and middle-income countries, Brazil (25,396), Mexico (15,941), Thailand (8,172) and Turkey (8,088) each received a high number of patent applications in 2019. The offices of Turkey (+8.3%) and Morocco (+7.6%) recorded particularly rapid growth in 2019. Among regional offices, the African Regional Intellectual Property Organization (ARIPO) (+4.5%) reported strong growth, whereas, conversely, the African Intellectual Property Organization (OAPI) (-6.7%) saw a substantial decrease. The Eurasian Patent Organization (EAPO) (-0.2%) recorded a small decline. For the numbers of patent applications received by all other IP offices (where available), see the statistical table starting on page 39.

The Republic of Korea continues to file the most patents per unit of GDP

7. Resident patent applications relative to GDP for the top 10 origins, 2019

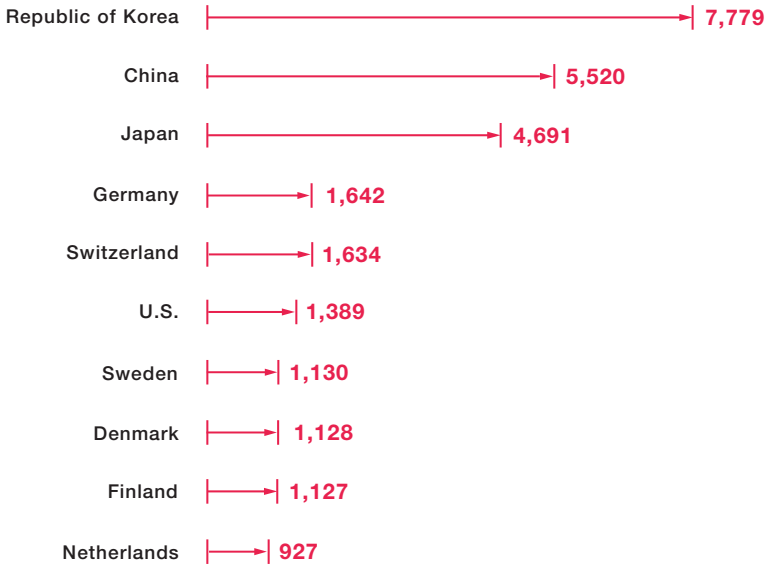

GDP data are in 2017 US purchasing power parity (PPP) dollars. The top 10 origins were included if they had a GDP greater than USD 25 billion PPP and more than 100 resident patent applications.

Sources: WIPO Statistics Database and World Bank, September 2020.

Differences in patent activity reflect both the size of an economy and its level of development. However, by weighing the number of applications per country relative to its GDP, it is possible to compare filing activity between countries with economies of very different sizes to arrive at an alternative measure.

With 7,779 resident patent applications per unit of USD 100 billion GDP, the Republic of Korea continued to file the greatest number of patent applications. China (5,520) had the second highest ratio in 2019, followed by Japan (4,691), Germany (1,642) and Switzerland (1,634). Among top 10 origins, China saw a considerable improvement in its resident patent applications to GDP ratio between 2009 and 2019.

Which countries specialize in which technologies?

8. The top three technology fields for each of the top five origins, 2016–2018

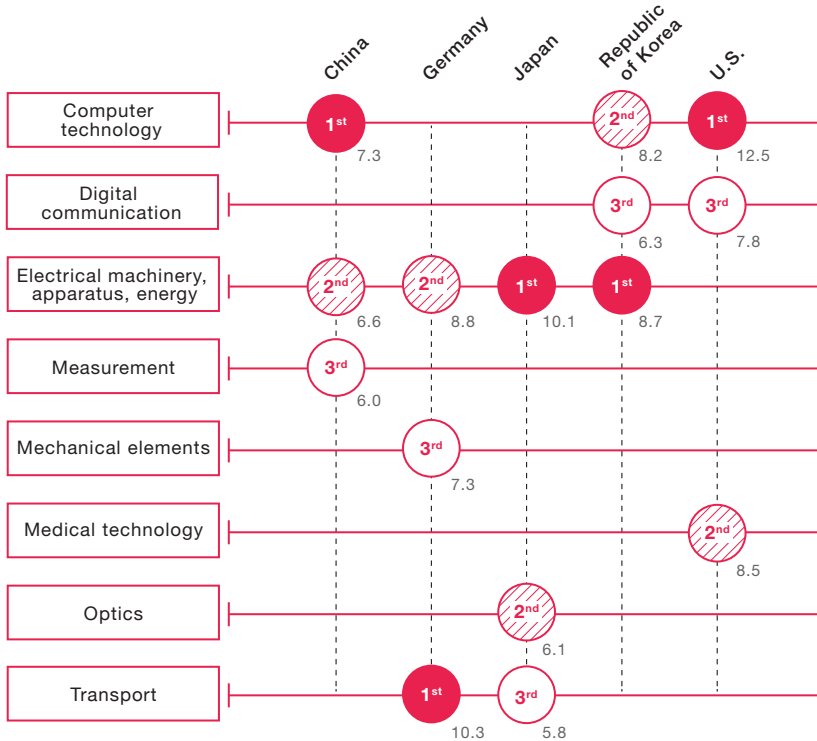

Numbers in gray show percentage share.

Sources: WIPO Statistics Database and EPO PATSTAT database, September 2020.

Analyzing patents by technology shows a country's areas of strength or specialization. For example, applicants from China and the U.S. filed most heavily in computer technology, applicants from Japan and the Republic of Korea in electrical machinery, and those from Germany in transport.

China in 2019 surpassed the U.S. to become the top filer of international patent applications

9. PCT international applications for the top 10 origins, 2019

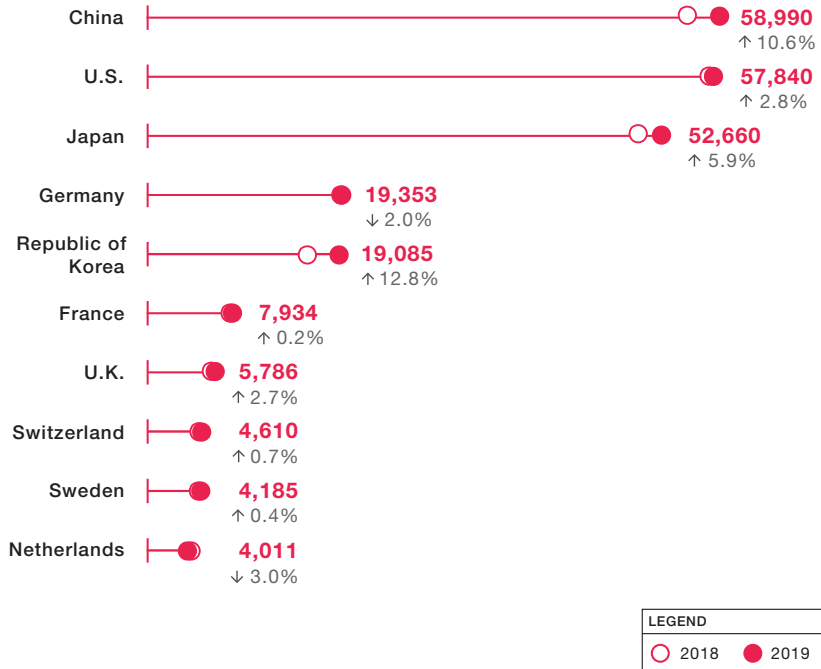

Source: WIPO Statistics Database, September 2020.

The Patent Cooperation Treaty (PCT) System simplifies the process of multiple national patent filings by reducing the requirement to file a separate application in each jurisdiction where protection is sought.

International patent applications filed via the PCT grew by 5.2% (265,800 applications) in 2019, representing a tenth consecutive year of growth. Applicants residing in China (58,990) filed the greatest number of PCT patent applications, followed closely by applicants from the U.S. (57,840) and Japan (52,660). Germany and the Republic of Korea ranked fourth and fifth, in 2019, with 19,353 and 19,085 applications, respectively.

For a third consecutive year, Huawei Technologies was the top PCT applicant in 2019

10. Top 10 PCT applicants, 2019

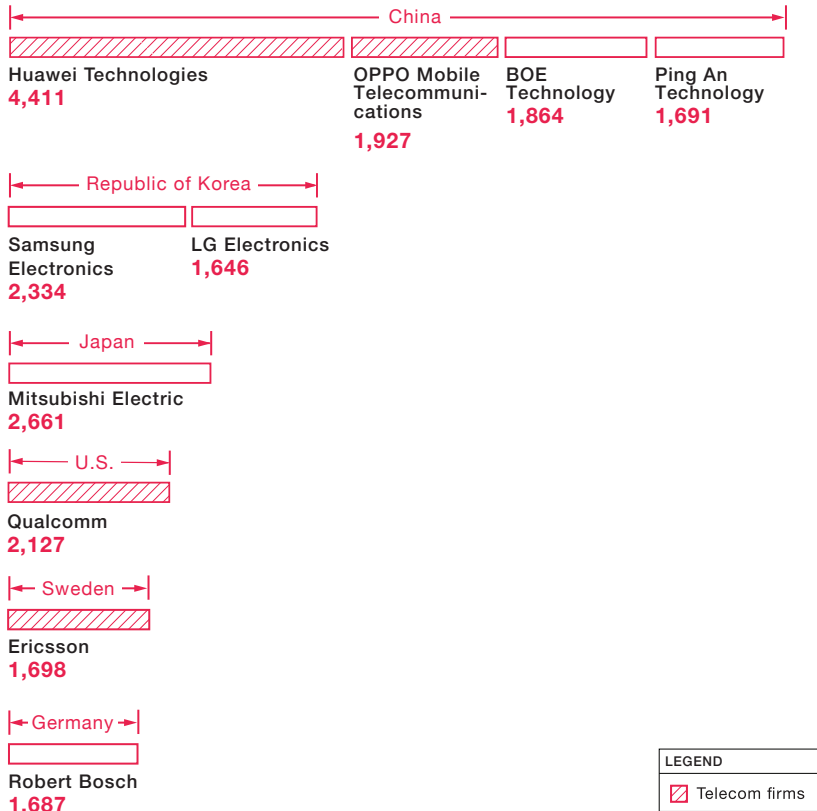

Source: WIPO Statistics Database, September 2020.

For a third consecutive year, China-based telecoms giant Huawei Technologies, with 4,411 published PCT applications, was the top corporate filer in 2019. It was followed by Mitsubishi Electric Corp. of Japan (2,661), Samsung Electronics of the Republic of Korea (2,334), Qualcomm Inc. of the U.S. (2,127) and Guang Dong Oppo Mobile Telecommunications of China (1,927). The top 10 applicant list comprises four companies from China, two from the Republic of Korea, and one each from Germany, Japan, Sweden and the U.S.

The IP office of China received 96.9% of all utility model applications filed worldwide in 2019

11. Utility model applications for the top 10 offices, 2019

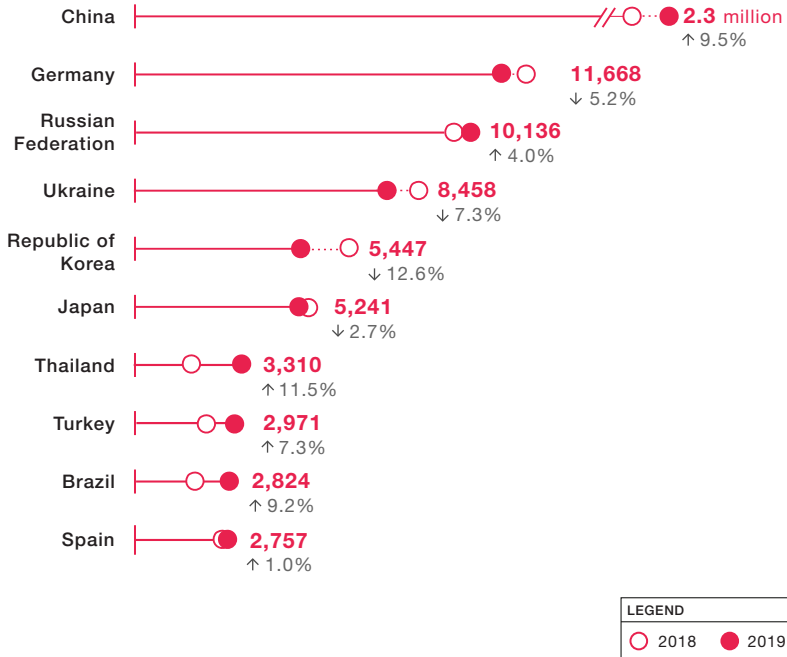

Source: WIPO Statistics Database, September 2020.

A utility model is a special form of patent right. It has less stringent requirements than a patent, but gives a shorter term of protection. Utility models are not available in all jurisdictions.

Of the 2.3 million applications filed globally in 2019, the IP office of China received 96.9% of the world total – the other 79 offices together receiving just 3.1%. Applications at the offices of Germany, Japan and the Republic of Korea declined substantially between 2009 and 2019. In contrast, China saw enormous growth over the same period.

Utility model filings grew markedly in the middle-income country of Indonesia

12. Utility model applications for offices of selected middle-income countries, 2019

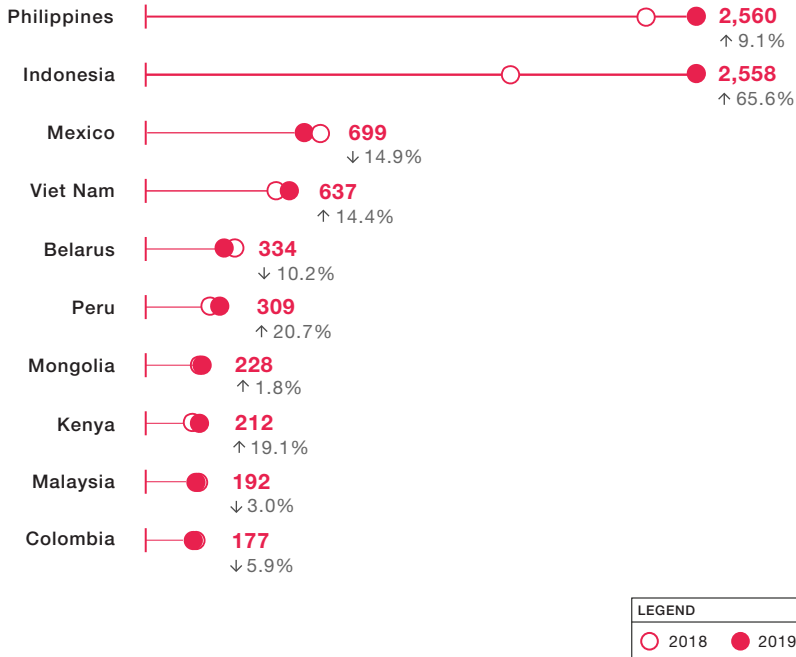

Source: WIPO Statistics Database, September 2020.

The chart above shows the number of utility model applications received by the IP offices of selected middle-income countries in 2019. Applications filed in Indonesia (+65.6%) grew strongly. Peru (+20.7%) and Kenya (+19.1%) also recorded strong growth in 2019. For the numbers of utility model applications received by all other IP offices (where available), see the statistical table starting on page 39.

Trademarks

Just five offices accounted for 65% of all trademark filing activity worldwide

13. Percentage shares of total trademark filing activity by the top five offices, 2019

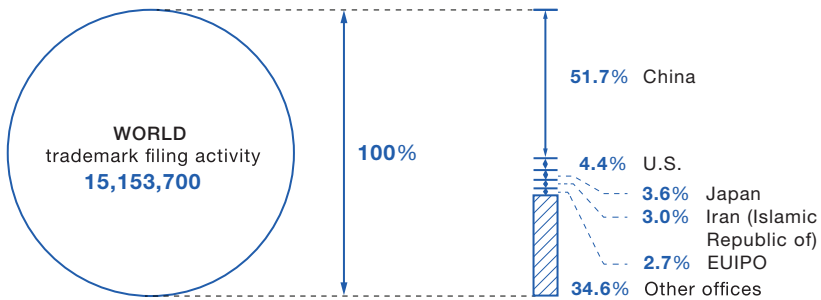

EUIPO is the European Union Intellectual Property Office.

Source: WIPO Statistics Database, September 2020.

About 65% of worldwide trademark filing activity – as measured in class counts – was concentrated at the top five offices in 2019. The office of China (51.7%) accounted for more than half of all global trademark filing activity, primarily from Chinese residents. The remaining four offices among the top five each accounted for less than 5% of the total.

Trademark filing activity in China is more than double that of the next nine largest offices combined

14. Application class counts for the top 10 offices, 2019

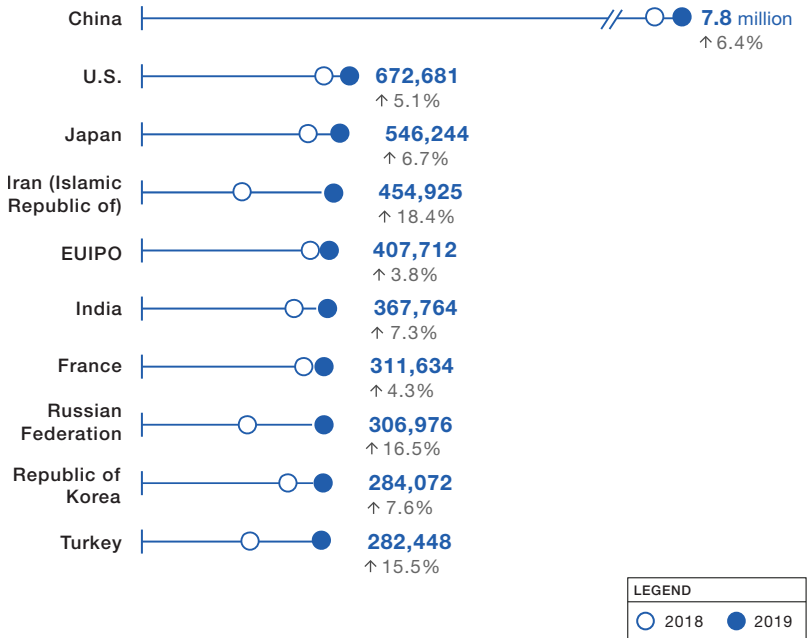

EUIPO is the European Union Intellectual Property Office.

Source: WIPO Statistics Database, September 2020.

The office of China's class count of 7.8 million was followed by a count of 672,681 at the office of the U.S. These have been the two top offices since the early 2000s, but from 2006 onwards China's class count has grown markedly, from about twice that of the U.S. to almost 12 times as much in both 2018 and 2019. This is due in large part to the high number of trademark applications filed by Chinese residents in China. These two top-ranked offices were followed by those of Japan (546,244), the Islamic Republic of Iran (454,925) and by the European Union Intellectual Property Office (EUIPO) (407,712).

All top 10 offices had higher levels of trademark filing activity in 2019 than in 2018. The largest increases were in the Islamic Republic of Iran (+18.4%), the Russian Federation (+16.5%) and Turkey (+15.5%).

Among offices of selected middle-income countries, Brazil not only recorded high trademark filing activity, but also recorded an impressive year-on-year growth of 22.3%

15. Application class counts for offices of selected middle-income countries, 2019

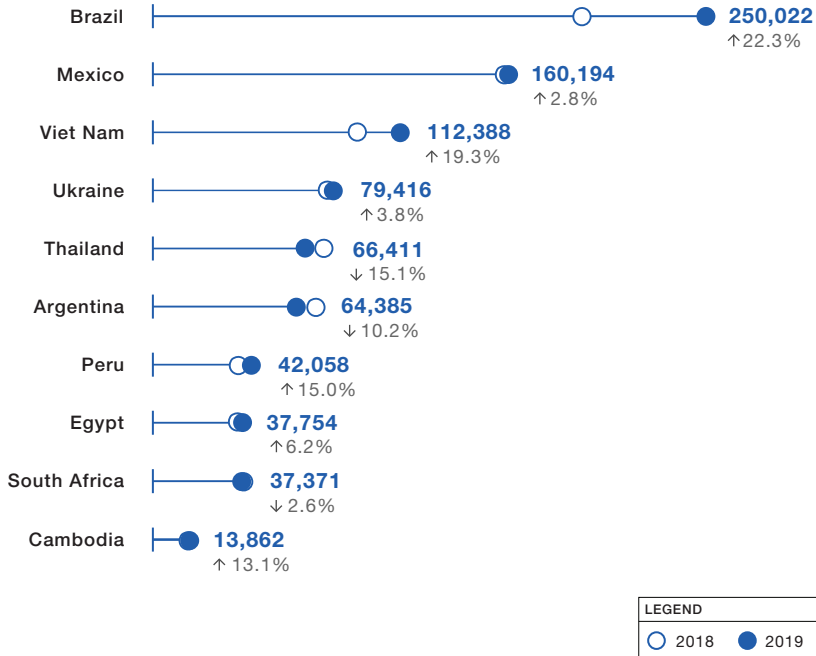

Source: WIPO Statistics Database, September 2020.

Brazil (250,022), Mexico (160,194) and Viet Nam (112,388) had considerably higher trademark filing activity – as measured in class counts – than many other middle-income countries.

The chart above shows the total number of classes specified in trademark applications received by the IP offices of selected middle-income countries in 2019. For the trademark application class counts for all other IP offices (where available), see the statistical table starting on page 39.

China and the Republic of Korea performed strongly on application class count per unit of GDP

16. Resident trademark application class count relative to GDP for selected origins, 2019

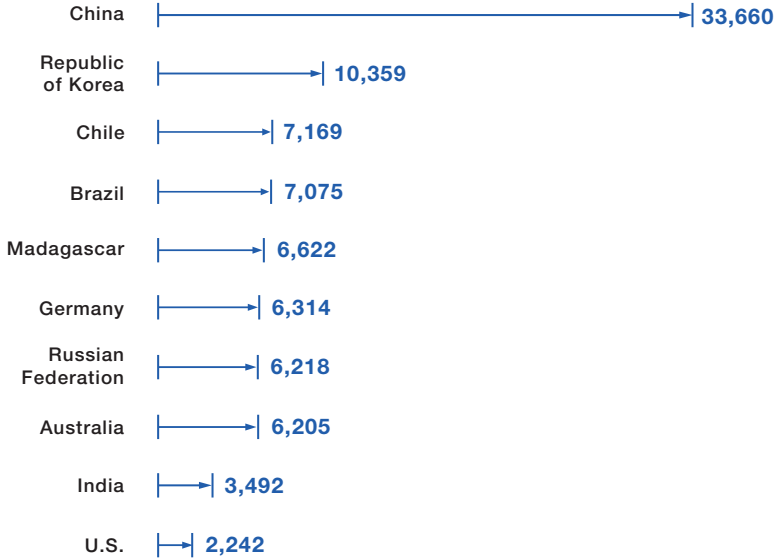

GDP data are in 2017 US purchasing power parity (PPP) dollars.

Sources: WIPO Statistics Database and World Bank, September 2020.

Calculating application class count per unit of USD 100 billion GDP allows us to compare trademark filing activity in countries with different filing systems (single-class versus multi-class) and economies of varying sizes. On this measure, smaller countries, such as Australia, Chile and Madagascar, rank higher than some larger countries with higher class counts in absolute terms, for example, India and the U.S.

What were the top industries for trademark filing by applicants from different countries?

17. The top three industry sectors for each of the top five origins, 2019

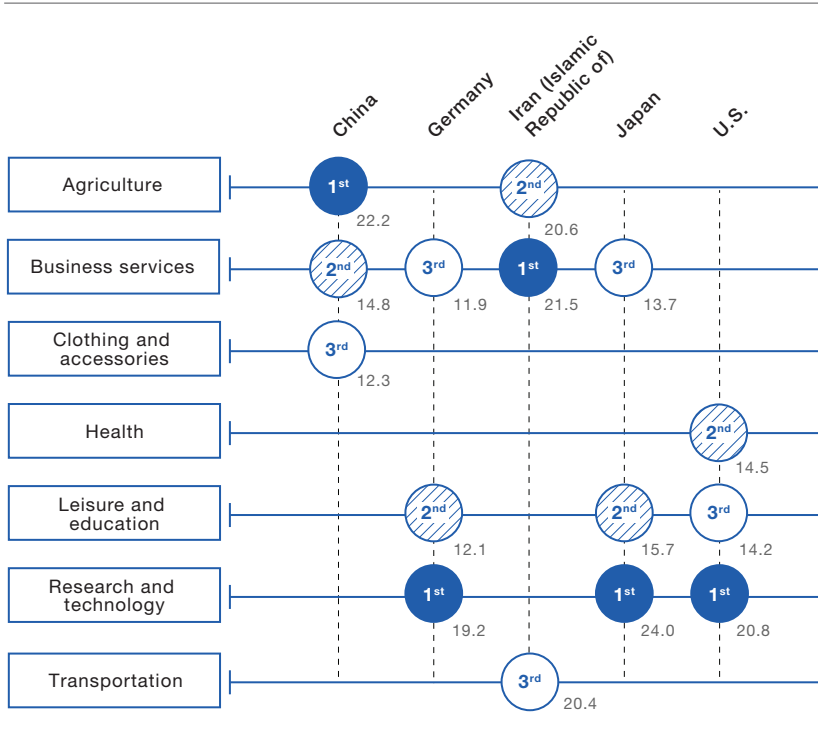

Numbers in gray show percentage share.

Source: WIPO Statistics Database, September 2020.

Using the Nice Classification, trademark applications can be attributed to 10 industry sectors. The chart above shows the top three industry sectors for each of the five origins with the highest trademark filing activity in 2019. Research and technology, leisure and education and business services feature as the three sectors to attract the highest volumes of trademark applications originating from Germany and Japan. Agriculture and business services were among the top three sectors for applicants from China and the Islamic Republic of Iran, and health was a top sector for applicants based in the U.S.

The U.S. and Germany continue to remain the biggest users of the Madrid System

18. Madrid international applications for the top 10 origins, 2019

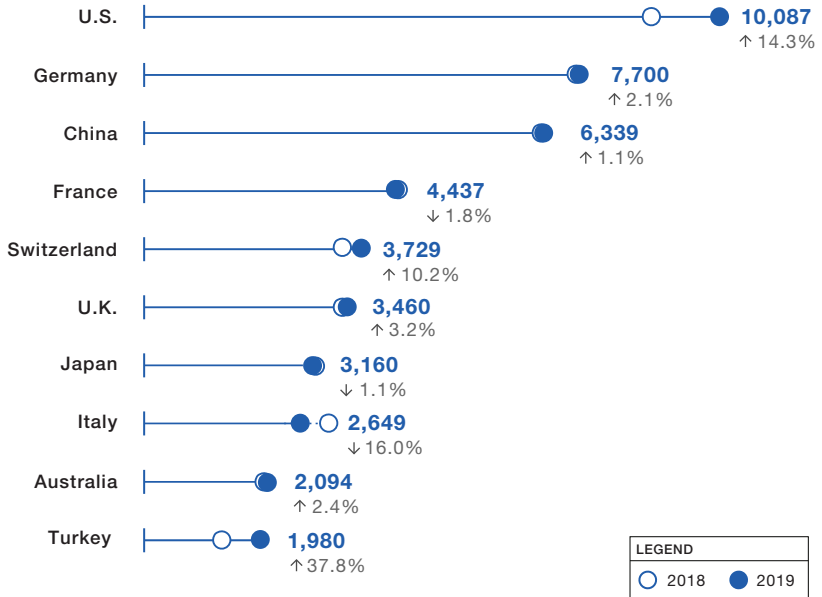

Source: WIPO Statistics Database, September 2020.

The WIPO-administered Madrid System makes it possible for a trademark holder to apply for trademark registration in multiple countries by filing a single international application via a national or regional IP office.

Applicants filed an estimated 64,400 Madrid international trademark applications in 2019. This is an increase of almost 3,500 on the previous year, resulting in an annual growth rate of 5.7% and marking a 10th year of uninterrupted expansion. Recording double-digit growth for the second year in a row, applicants based in the U.S. continued to top the list of origins with the greatest number of international applications filed via the Madrid System. A strong year-on-year growth of 14.3% resulted from an estimated 10,087 Madrid applications filed by U.S.-based applicants in 2019. This was followed by applications from Germany (7,700), China (6,339), France (4,437) and Switzerland (3,729).

French personal care and cosmetics company L'Oréal was the top applicant in 2019

19. Top 10 Madrid applicants, 2019

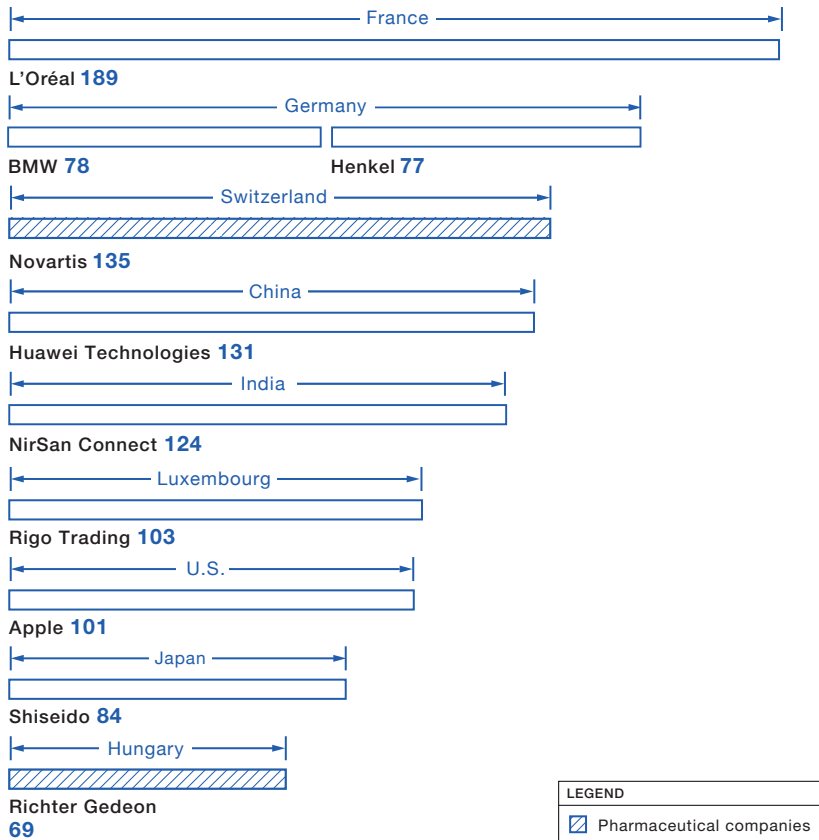

Source: WIPO Statistics Database, September 2020.

With 189 Madrid applications, French personal care and cosmetics company L'Oréal was the top applicant in 2019, followed by pharmaceutical company Novartis AG of Switzerland (135), technology company Huawei Technologies of China (131) and research and advisory company NirSan Connect of India (124). This is the first year when applicants based in middle-income Asian countries appear among the top five applicants, which prior to 2019 had primarily consisted of European companies.

Industrial designs

The office of China accounted for more than half of all industrial design filing activity worldwide

20. Percentage shares of total design filing activity by the top five offices, 2019

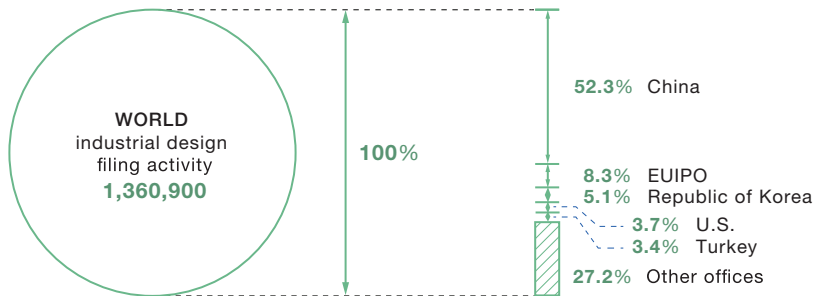

EUIPO is the European Union Intellectual Property Office.

Source: WIPO Statistics Database, September 2020.

WIPO uses the application design count to measure filing activity for industrial designs; in other words, it does not just count the number of applications, but counts the number of designs in applications. Design count is a better way of comparing filing activity across IP offices, because at some offices users are able to register multiple designs through a single application.

In 2019, just over one million industrial design applications were filed worldwide. These applications contained a total of 1.4 million designs.

Almost 73% of global industrial design filing activity – as measured by design counts – took place at the top five offices in 2019, with the office of China alone receiving 52.3% the world total. The EUIPO (8.3%) and the Republic of Korea (5.1%) received the second and third largest shares of total filing activity, respectively.

Among top 10 offices, Turkey experienced the sharpest increase in filings

21. Application design counts for the top 10 offices, 2019

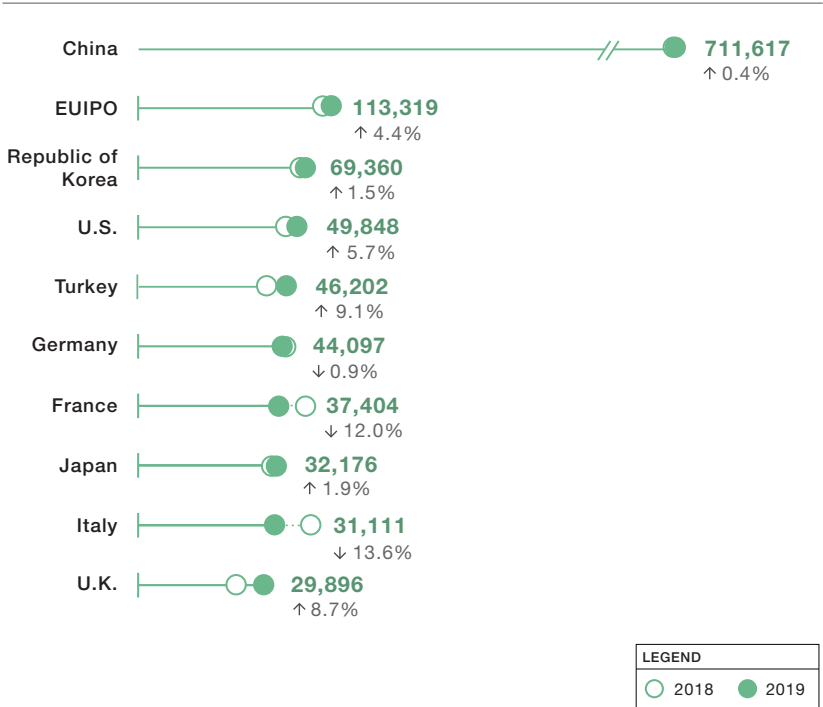

EUIPO is the European Union Intellectual Property Office.

Source: WIPO Statistics Database, September 2020.

Among top 10 offices, Turkey (+9.1%), the United Kingdom (U.K.) (+8.7%), the U.S. (+5.7%) and the EUIPO (+4.4%) recorded the strongest annual growth in the number of designs in applications received in 2019, whereas Italy (-13.6%) and France (-12%) each saw a sharp year-on-year decline.

Among offices of middle-income countries, filing activity was again particularly high in the Islamic Republic of Iran and India

22. Application design counts for offices of selected middle-income countries, 2019

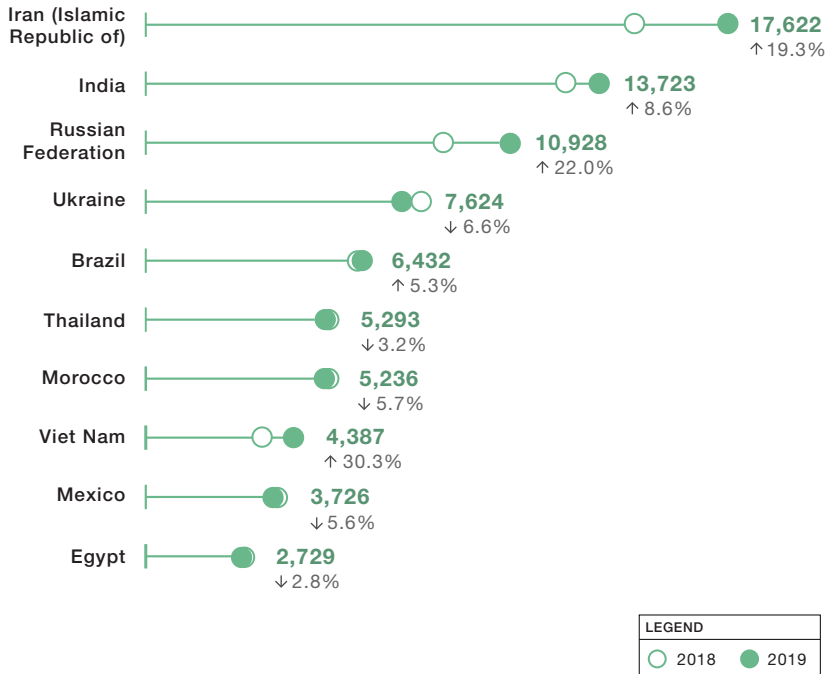

Source: WIPO Statistics Database, September 2020.

With 17,622 designs in applications received, the IP office of the Islamic Republic of Iran had considerably higher filing activity than had the offices of most other middle-income countries in 2019. India (13,723 designs), the Russian Federation (10,928), Ukraine (7,624), Brazil (6,432) and Thailand (5,293) also ranked among the top 20 offices in the world in terms of design filing activity.

The chart above shows the total numbers of designs contained in applications filed at the IP offices of selected middle-income countries in 2019. For the application design counts for all other IP offices (where available), see the statistical table starting on page 39.

China leads the world in the number of designs in applications per unit of GDP

23. Resident application design count relative to GDP for selected origins, 2019

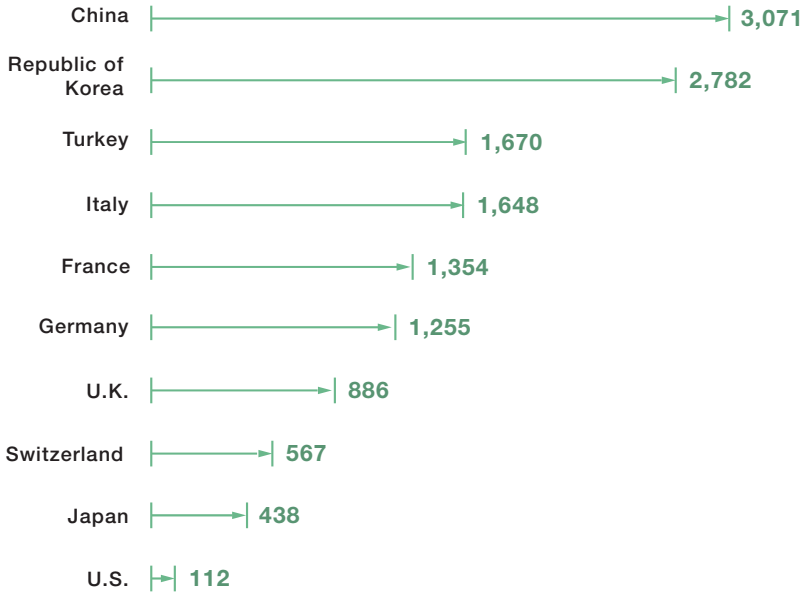

GDP data are in 2017 US purchasing power parity (PPP) dollars.

Sources: WIPO Statistics Database and World Bank, September 2020.

Calculating design counts per unit of USD 100 billion GDP enables a comparison to be made between the industrial design filing activity of residents of countries whose filing systems are different (single-design versus multi-design) and whose economies are of varying sizes. On this measure, China and the Republic of Korea performed strongly. They had the highest resident design count per unit of GDP in 2019, followed by Turkey, Italy and France.

Which industries led design filing by applicants from different countries?

24. The top three industry sectors for each of the selected origins, 2019

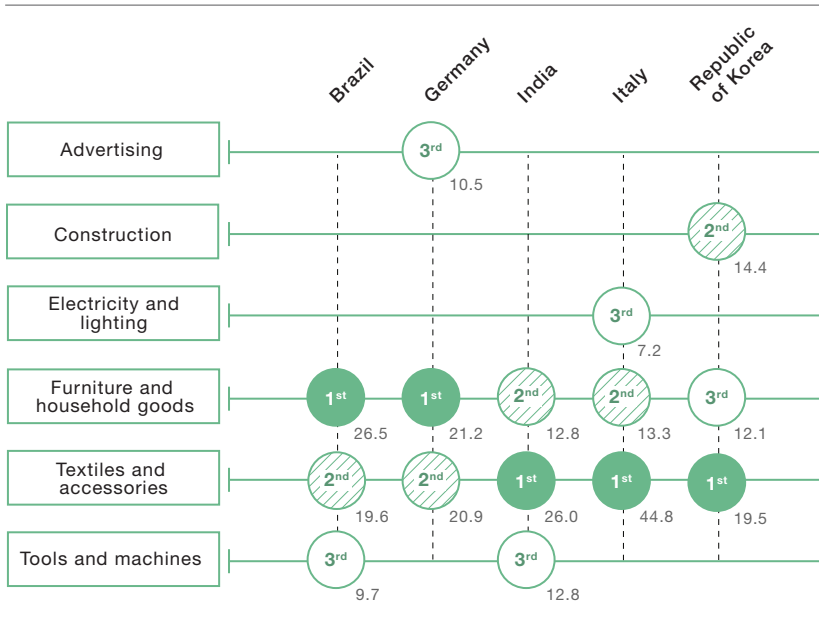

Numbers in gray show percentage share.

Source: WIPO Statistics Database, September 2020.

Grouping the 32 Locarno classes into 12 industry sectors allows us to analyze the areas of strength or specialization of different countries. Both the furniture and household goods sector and the textiles and accessories sector featured among the top three sectors for designs counts for all five selected origins. Advertising was one of the top three sectors for applicants located in Germany, while construction ranked among the top three for those in the Republic of Korea, electricity and lighting for applicants based in Italy, and tools and machines for those in Brazil and India.

The Republic of Korea has become the second biggest user of the Hague System

25. Designs in Hague international applications for the top 10 origins, 2019

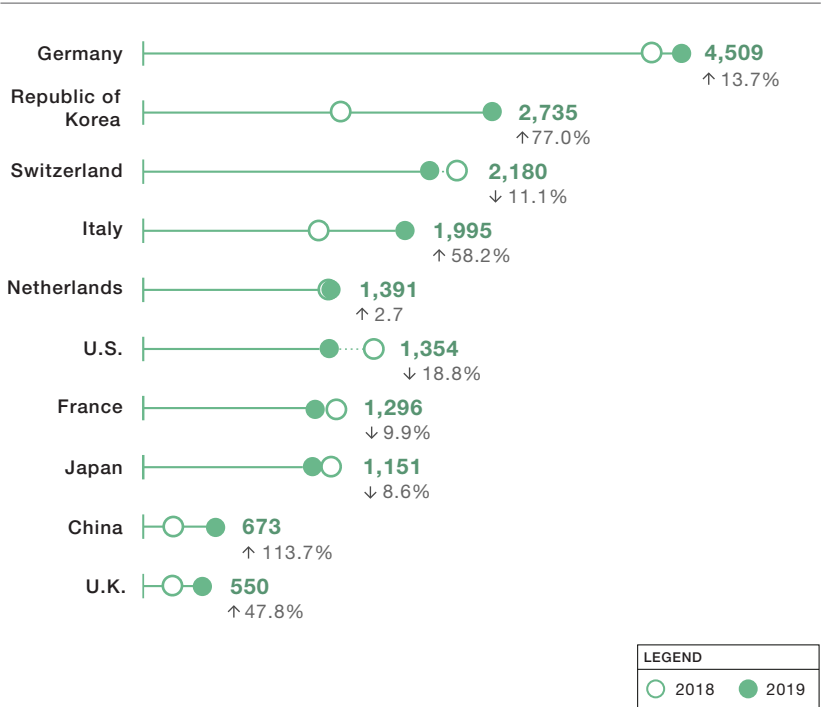

Source: WIPO Statistics Database, September 2020.

The Hague System makes it possible for an applicant to obtain protection for their industrial designs in multiple jurisdictions by filing a single application with the International Bureau of WIPO. This simplifies the process of multinational registration by eliminating the requirement to file a separate application in each jurisdiction in which protection is sought. Hague applicants can protect up to 100 industrial designs for products belonging to one and the same class through a single application.

In 2019, the Hague System received 5,894 international applications, up 8.1% on 2018. These applications contained 21,857 designs, representing an increase of 10.6% on the previous year and a 13th year of uninterrupted growth.

Applicants based in Germany remained the biggest users of the Hague System, with 4,509 designs in applications. The Republic of Korea (2,735 designs) overtook Switzerland (2,180) to rank second in 2019. Switzerland, which remained second for a 13th consecutive year, recorded double-digit drops in both 2018 and 2019.

Of the top 10 origins, China was the one to see the fastest growth in 2019. Designs originating from China grew by 113.7%, albeit from a low base, up from 315 designs in 2018 to 673 designs in 2019. China was followed by the Republic of Korea (+77%), Italy (+58.2%) and the U.K. (+47.8%). In contrast, the U.S. (-18.8%), Switzerland (-11.1%), France (-9.9%) and Japan (-8.6%) all saw declines.

For a third consecutive year, Samsung Electronics of the Republic of Korea headed the list of top Hague System applicants

26. Top 10 Hague applicants, 2019

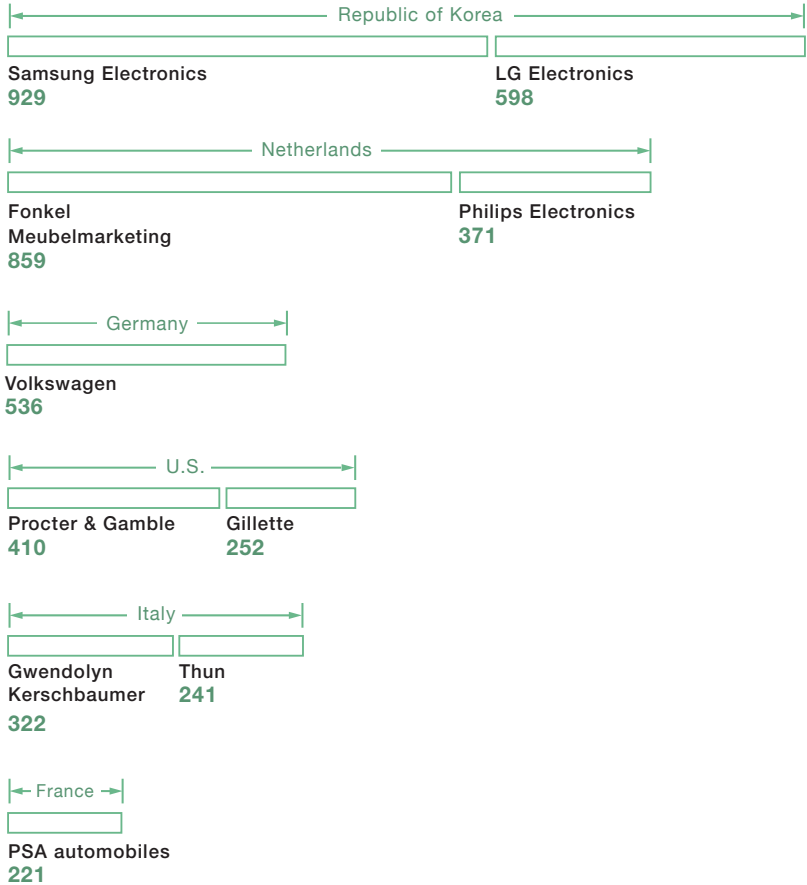

Source: WIPO Statistics Database, September 2020.

For a third consecutive year, Samsung Electronics of the Republic of Korea headed the list of top Hague System applicants. It was followed by the Netherlands' Fonkel Meubelmarketing, LG Electronics of the Republic of Korea, Volkswagen

of Germany and the U.S.-based company Procter & Gamble. Only three companies have held the position of top applicant over the past 10 years: Fonkel Meubelmarketing, Procter & Gamble and Samsung Electronics.

The top 10 applicants represent a diverse set of industries that includes automobiles, electronics, furnishing and household/consumer goods.

Additional information

Statistical tables

Applications by office, 2019

IP office ^a	Applications			
	Patent	Utility model	Trademark class count ^b	Industrial design count ^c
African Intellectual Property Organization	514	15	13,966	1,132
African Regional Intellectual Property Organization	868	24	725	76
Albania	5	1	8,395	..
Algeria	638	1,682
Andorra	15	..	2,552	..
Angola	110	8	4,333	..
Argentina	3,702	155	64,385	2,049
Armenia	116	37	11,978	491
Australia	29,758	1,859	140,098	8,857
Austria	2,274	450	26,012	..
Azerbaijan	167	58	13,288	961
Bahrain	326	..	12,282	62
Bangladesh	413	..	12,435	1,598
Barbados	31	..	1,031	..
Belarus	393	334	19,779	709
Belgium ^(d)	1,133
Belize	32	262
Benelux Office for Intellectual Property	53,757	1,470
Bosnia and Herzegovina	59	..	9,921	734
Botswana	2	15	3,431	..
Brazil	25,396	2,824	250,022	6,432
Brunei Darussalam	141	..	4,727	116
Bulgaria	193	454	16,513	842
Cabo Verde	1	..	284	..
Cambodia	13,862	..
Canada	36,488	..	193,670	7,538
Chile	3,237	138	46,947	528
China	1,400,661	2,268,190	7,833,081	711,617
China, Hong Kong SAR	16,532	791	76,892	4,974
China, Macao SAR	38	32	15,363	234
Colombia	2,157	177	47,996	668
Costa Rica	499	8	15,823	73
Croatia	211	59	9,729	1,083
Cuba	115	5	7,958	24
Curaçao	2,414	..
Cyprus	5	85
Czech Republic	813	1,301	25,451	1,074

IP office ^a	Applications			
	Patent	Utility model	Trademark class count ^b	Industrial design count ^c
Denmark	1,579	110	10,460	352
Dominica	151	..
Dominican Republic	243	22	13,509	40
Ecuador	437	59	19,350	154
Egypt	2,183	..	37,754	2,729
El Salvador	148	5	8,121	41
Estonia	32	73	5,524	104
Eurasian Patent Organization	3,482
European Patent Office	181,479
European Union Intellectual Property Office	407,712	113,319
Finland	1,396	313	9,285	344
France	15,869	454	311,634	37,404
Gambia	16	..	2,211	..
Georgia	197	75	11,274	690
Germany	67,434	11,668	235,928	44,097
Greece	594	29	..	1,205
Guatemala	238	11	12,621	205
Honduras	187	3	7,538	..
Hungary	450	255	8,135	504
Iceland	62	..	9,080	417
India	53,627	..	367,764	13,723
Indonesia	11,481	2,558	85,837	2,668
Iran (Islamic Republic of)	12,147	..	454,925	17,622
Ireland	93	124	7,548	182
Israel	7,738	..	21,651	1,483
Italy	10,127	1,916	97,077	31,111
Jamaica	65	..	6,378	207
Japan	307,969	5,241	546,244	32,176
Jordan	311	..	6,806	118
Kazakhstan	27,485	..
Kenya	335	212	13,282	165
Kyrgyzstan	93	19	7,609	..
Latvia	87	..	5,736	173
Liechtenstein (e)	9,082	992
Lithuania	123	..	6,909	634
Luxembourg (d)	476
Madagascar	30	..	6,191	318
Malaysia	7,551	192	46,707	1,904
Malta	12	..	731	11
Mauritius	27	..	4,613	126
Mexico	15,941	699	160,194	3,726
Monaco	15	..	8,911	972
Mongolia	170	228	16,525	1,216
Montenegro	16	..	8,573	872
Morocco	2,730	..	30,215	5,236

IP office ^a	Applications			
	Patent	Utility model	Trademark class count ^b	Industrial design count ^c
Mozambique	47	11	5,705	77
Namibia	20	8	6,493	193
Netherlands (d)	2,677
New Zealand	6,014	..	50,715	1,281
Nigeria	18,658	..
North Macedonia	735
Norway	1,539	..	43,147	4,641
Oman	506	..	16,024	559
Pakistan	874	..	38,332	581
Panama	362	3	11,127	92
Patent Office of the Cooperation Council for the Arab States of the Gulf	2,162
Peru	1,259	309	42,058	382
Philippines	4,380	2,560	62,672	1,735
Poland	3,999	911	38,781	..
Portugal	807	93	36,063	2,058
Qatar	838	..	8,372	..
Republic of Korea	218,975	5,447	284,072	69,360
Republic of Moldova	100	138	11,341	1,174
Romania	939	46	25,515	1,061
Russian Federation	35,511	10,136	306,976	10,928
Rwanda	..	18	3,140	71
Saint Vincent and the Grenadines	3	..	423	..
Samoa	3	3	1,164	40
San Marino	752	108
Sao Tome and Principe	1,767	..
Saudi Arabia	3,651	..	37,669	804
Serbia	177	82	16,267	1,156
Seychelles	12	..	645	5
Sierra Leone	2,686	..
Singapore	14,136	..	53,288	4,769
Slovakia	234	325	13,639	410
South Africa	6,914	..	37,371	1,884
Spain	1,447	2,757	80,805	16,175
Sri Lanka	611	..	10,385	546
Sudan	245	..	5,243	..
Sweden	2,190	..	19,646	658
Switzerland	1,717	..	96,343	12,621
Syrian Arab Republic	153	..	13,185	240
Tajikistan	2	..	6,479	..
Thailand	8,172	3,310	66,411	5,293
Trinidad and Tobago	113	..	2,532	24
Turkey	8,088	2,971	282,448	46,202
Ukraine	3,852	8,458	79,416	7,624
United Arab Emirates	1,904	9	18,686	916

IP office ^a	Applications			
	Patent	Utility model	Trademark class count ^b	Industrial design count ^c
United Kingdom	19,250	..	220,371	29,896
United Republic of Tanzania	..	1
United States of America	621,453	..	672,681	49,848
Uruguay	9,369	..
Uzbekistan	543	277	15,728	266
Viet Nam	7,520	637	112,388	4,387
Yemen	75	..	5,690	51
Zambia	23	..	4,843	58
Zimbabwe	3,816	..
World total (2019 estimate)	3,224,200	2,341,180	15,153,700	1,360,900

a. Not all listed countries/territories/intergovernmental organizations have an IP office. Also, some offices do not receive applications for some IP rights. Only those offices with at least one application filed are presented.

b. Application class count is the sum of classes specified in applications received directly by an office plus, where applicable, those specified in designations received by the office via the Madrid System.

c. Application design count is the sum of designs contained in applications received directly by an office plus, where applicable, those contained in designations received by the office via the Hague System.

d. This country does not have a national trademark or industrial design office. All applications for trademark and design protection are filed at the Benelux Office for Intellectual Property (BOIP) or the European Union Intellectual Property Office (EUIPO).

e. The Swiss Federal Institute of Intellectual Property acts as the receiving office for patent applications.

.. indicates either zero, not available or not applicable.

Source: WIPO Statistics Database, September 2020.

International applications by origin via the PCT, Madrid and Hague Systems, 2019

Origin ^a	International applications		
	PCT	Madrid	Hague ^b
Albania	3	12	..
Algeria	9	6	..
Andorra	4	1	..
Antigua and Barbuda	47	4	..
Argentina	36	2	..
Armenia	3	30	7
Australia	1,768	2,094	6
Austria	1,444	1,059	165
Azerbaijan	12	5	..
Bahamas	2	6	..
Bahrain	2
Bangladesh	2
Barbados	79	2	..
Belarus	16	194	..
Belgium	1,355	752	107
Belize	..	5	..
Benin	1
Bermuda	15	19	..
Bosnia and Herzegovina	2	59	75
Botswana	..	2	..
Brazil	644	31	..
Brunei Darussalam	2	2	..
Bulgaria	49	223	45
Burkina Faso	1
Cabo Verde	..	1	..
Cambodia	..	4	..
Cameroon	1	5	2
Canada	2,711	359	83
Chile	224	2	..
China	58,990	6,339	673
China, Hong Kong SAR	..	1	..
Colombia	127	55	..
Congo	1
Costa Rica	12
Côte d'Ivoire	1	13	..
Croatia	41	172	51
Cuba	9	13	..
Curaçao	..	7	..
Cyprus	44	231	408
Czech Republic	186	374	131
Democratic People's Republic of Korea	1	10	..
Denmark	1,452	565	432
Dominican Republic	13	1	1
Ecuador	18	1	..

Origin ^a	International applications		
	PCT	Madrid	Hague ^b
Egypt	44	21	..
El Salvador	2
Equatorial Guinea	..	1	..
Estonia	38	103	6
Ethiopia	1	1	..
Fiji	1
Finland	1,655	465	46
France	7,934	4,437	1,296
Georgia	6	30	1
Germany	19,353	7,700	4,509
Greece	123	129	9
Guinea	..	3	..
Hungary	157	199	70
Iceland	41	31	4
India	2,053	460	3
Indonesia	7	57	..
Iran (Islamic Republic of)	229	24	2
Iraq	2	2	..
Ireland	642	192	21
Israel	2,006	340	4
Italy	3,388	2,649	1,995
Jamaica	1
Japan	52,660	3,160	1,151
Jordan	19
Kazakhstan	27	159	1
Kenya	8	18	..
Kuwait	5
Kyrgyzstan	2	14	..
Lao People's Democratic Republic	..	3	..
Latvia	36	133	3
Lebanon	3	11	1
Liechtenstein	265	90	129
Lithuania	32	137	16
Luxembourg	348	407	171
Madagascar	..	5	..
Malaysia	202	21	..
Maldives	1
Malta	38	58	..
Marshall Islands	..	6	..
Mauritius	10	10	..
Mexico	220	113	..
Monaco	12	110	8
Mongolia	..	3	..
Montenegro	1	5	..
Morocco	34	90	39

Origin ^a	International applications		
	PCT	Madrid	Hague ^b
Mozambique	1
Namibia	3
Netherlands	4,011	1,414	1,391
New Zealand	250	566	2
Nigeria	1
North Macedonia	5	35	7
Norway	781	327	119
Oman	10	..	1
Others/Unknown	240	295	6
Pakistan	1
Panama	17	2	..
Paraguay	..	4	..
Peru	26
Philippines	21	87	..
Poland	364	512	106
Portugal	196	223	55
Qatar	25
Republic of Korea	19,085	1,392	2,735
Republic of Moldova	7	66	18
Romania	42	95	8
Russian Federation	1,218	1,712	160
Rwanda	..	3	..
Saint Kitts and Nevis	5
Samoa	1
San Marino	5	7	..
Saudi Arabia	552	..	1
Senegal	4	7	..
Serbia	38	193	39
Seychelles	1	10	..
Singapore	1,029	735	34
Sint Maarten (Dutch Part)	..	4	..
Slovakia	41	96	43
Slovenia	89	208	51
South Africa	281	7	13
Spain	1,513	1,360	247
Sri Lanka	17	1	..
Sudan	3	1	..
Sweden	4,185	825	434
Switzerland	4,610	3,729	2,180
Syrian Arab Republic	3	1	1
Tajikistan	..	8	..
Thailand	146	137	..
Trinidad and Tobago	3
Tunisia	11	29	88

Origin ^a	International applications		
	PCT	Madrid	Hague ^b
Turkey	2,058	1,980	389
Turkmenistan	1	1	..
Uganda	2
Ukraine	184	496	128
United Arab Emirates	108	23	15
United Kingdom	5,786	3,460	550
United States of America	57,840	10,087	1,354
Uruguay	10
Uzbekistan	1	14	..
Vanuatu	..	1	..
Venezuela (Bolivarian Republic of)	1
Viet Nam	34	187	10
Zambia	..	2	..
Zimbabwe	2
Total (2019 estimates)	265,800	64,400	21,857

a. Origin is defined as the country/territory of the stated address of residence of the applicant. Only origins with at least one international application filed in 2019 are presented.

b. Data represent the number of designs contained in Hague international applications.

.. indicates zero or not applicable.

Source: WIPO Statistics Database, September 2020.

Statistical resources

IP Statistics Data Center

The WIPO IP Statistics Data Center is a free online service for accessing WIPO's statistics on patents, utility models, trademarks, industrial designs and the use of the PCT, Madrid and Hague Systems. Users can select from a wide range of indicators to view or download data. This tool is intended for IP professionals, researchers and policymakers and can be accessed via the IP Statistics webpage: www.wipo.int/ipstats.

The IP Statistics Data Center is also available in Arabic, Chinese, French, Russian and Spanish.

IP Statistical Country Profiles

Visit WIPO's IP Statistical Country Profile webpages for more statistics and longer time series for patent, utility model, trademark and industrial design data. Like WIPO's IP Statistics Data Center, this service can be accessed via the IP Statistics webpage: www.wipo.int/ipstats.

The IP Statistical Country Profiles are also available in Arabic, Chinese, French, Russian and Spanish.

Glossary

Class count

The number of classes specified in a trademark application or registration. In the international trademark system and at certain national and regional offices, an applicant can file a trademark application specifying one or more of the 45 goods and services classes of the Nice Classification. Offices use either multi-class or a single filing system. For example, the offices of Japan, the Republic of Korea and the United States of America (U.S.), as well as many European IP offices, have multi-class filing systems. On the other hand, the offices of Brazil, Mexico and South Africa follow a single-class filing system, requiring a separate application for each class in which an applicant seeks trademark protection. To capture the differences in application and registration numbers across offices, it is useful to compare their respective application and registration class counts.

Design count

The number of designs contained in an industrial design application or registration. Under the Hague System for the International Registration of Industrial Designs, it is possible for an applicant to obtain protection for up to 100 industrial designs for products belonging to one and the same class by filing a single application. Some national or regional IP offices allow applications to contain more than one design for the same product or within the same class, while others allow only one design per application. In order to capture the differences in application and registration numbers across offices, it is useful to compare their respective application and registration design counts.

Hague international application

An application for the international registration of an industrial design filed under the WIPO-administered Hague System.

Hague System

The abbreviated form of the Hague System for the International Registration of Industrial Designs. The System comprises two international treaties: the Hague Act of 1960 and the Geneva Act of 1999. The Hague System makes it possible for an applicant to register up to 100 industrial designs in multiple jurisdictions by filing a single application with the International Bureau of WIPO. It simplifies multinational registration by reducing the requirement to file separate applications with each IP office. The System also simplifies the subsequent management of the industrial design, since it is possible to record changes or renew a registration through a single procedural step for all designated Hague members.

Industrial design

Industrial designs are applied to a wide variety of industrial products and hand-crafts. They refer to the ornamental or aesthetic aspects of a useful article, including compositions of lines or colors or any three-dimensional forms that give a special appearance to a product or handicraft. The holder of a registered industrial design has exclusive rights against unauthorized copying or imitation of the design by third parties. Industrial design registrations are valid for a limited period. The term of protection is usually 15 years in most jurisdictions. However, differences in legislation exist, notably in China (which provides for a 10-year term from the application date).

In force

Refers to IP rights that are currently valid or, in the case of trademarks, active. To remain in force, IP protection must be maintained.

Intellectual property (IP)

Refers to creations of the mind: inventions, literary and artistic works, and symbols, names, images and designs used in commerce. IP is divided into two categories: industrial property – which includes patents, utility models, trademarks, industrial designs and geographical indications of source – and copyright, which includes literary and artistic works (such as novels, poems, plays, films), musical works, artistic works (such as drawings, paintings, photographs and sculptures) and architectural designs. Rights related to copyright include those of performing artists in their performances, those of producers of sound recordings in their recordings and those of broadcasters in their radio and television programs.

Madrid international application

An application for international registration under the Madrid System, which is a request for the protection of a trademark in one or more Madrid member jurisdiction. An international application must be based on a basic mark, that is, prior application or registration of a mark in a Madrid member jurisdiction.

Madrid System

An abbreviation describing the system for the international registration of trademarks, originally established by the Madrid Agreement Concerning the International Registration of Marks and later also governed by the Protocol Relating to the Madrid Agreement. Following a decision by the Madrid Union

Assembly in October 2016, the Protocol is now the sole governing treaty of the Madrid System. The Madrid System is administered by the International Bureau of WIPO.

Patent

A set of exclusive rights granted by law to applicants for inventions that are new, non-obvious and commercially applicable. A patent is valid for a limited period of time (generally 20 years), during which time patent holders can commercially exploit their inventions on an exclusive basis. In return, applicants are obliged to disclose their inventions to the public in a manner that enables others skilled in the art to replicate the invention. The patent system is designed to encourage innovation by providing innovators with time-limited exclusive legal rights, thus enabling them to appropriate the returns from their innovative activity.

PCT application

A patent application filed through the WIPO-administered PCT, also known as an international application.

PCT System

The PCT, an international treaty administered by WIPO, facilitates the acquisition of patent rights in a large number of jurisdictions. The PCT System simplifies the process of multiple national patent filings by reducing the requirement to file a separate application in each jurisdiction. However, the decision on whether to grant patent rights remains in the hands of national and regional patent offices, and patent rights remain limited to the jurisdiction of the patent granting authority. The PCT application process starts with the international phase, during which an international search and, possibly, a preliminary examination are performed, and concludes with the national phase, during which a national or regional patent office decides on the patentability of an invention according to national law.

Resident

For statistical purposes, a resident application refers to an application filed with the IP office of, or acting for, the state or jurisdiction in which the first named applicant in the application has residence. For example, an application filed with the Japan Patent Office (JPO) by a resident of Japan is considered a resident application from the perspective of the JPO. Resident applications are sometimes referred to as “domestic applications.” A resident grant/registration is an IP right issued on the basis of a resident application.

Trademark

A sign used to distinguish the goods or services of one undertaking from those of others. A trademark may consist of words and combinations of words (for

instance, names or slogans), logos, figures and images, letters, numbers, sounds, or, in rare instances, smells or moving images, or a combination thereof. The procedures for registering trademarks are governed by the legislation and procedures of national and regional IP offices and WIPO. Trademark rights are limited to the jurisdiction of the IP office that registers the trademark. Trademarks can be registered by filing an application at the relevant national or regional office(s), or by filing an international application through the Madrid System.

Utility model

A special form of patent right granted by a state or jurisdiction to an inventor or the inventor's assignee for a fixed period of time. The terms and conditions for granting a utility model are slightly different from those for normal patents (including a shorter term of protection and less stringent patentability requirements). The term "utility model" can also describe what are known in certain countries as "petty patents," "short-term patents" or "innovation patents."

World Intellectual Property Organization (WIPO)

A United Nations specialized agency dedicated to the promotion of innovation and creativity for the economic, social and cultural development of all countries through a balanced and effective international IP system. WIPO was established in 1967 with a mandate to promote the protection of IP throughout the world through cooperation between states and in collaboration with other international organizations.

World Intellectual Property Organization
34, chemin des Colombettes
P.O. Box 18
CH-1211 Geneva 20
Switzerland

Tel: + 41 22 338 91 11
Fax: + 41 22 733 54 28

For contact details of WIPO's
External Offices visit:
www.wipo.int/about-wipo/en/offices

WIPO Publication No. 943E/20
ISBN 978-92-805-3208-1